

ILLUSTRATED PARTS BREAKDOWN

**McCULLOCH
4.5 HORSEPOWER
21" REAR-DISCHARGE LAWN MOWER
MODEL NUMBER SN45Y31C (SN45Y21CA)
PRODUCT NUMBER 964 77 11-03**

ROTARY LAWN MOWER -- MODEL NUMBER SN45Y21C (SN45Y21CA) PRODUCT NUMBER 964 77 11-03

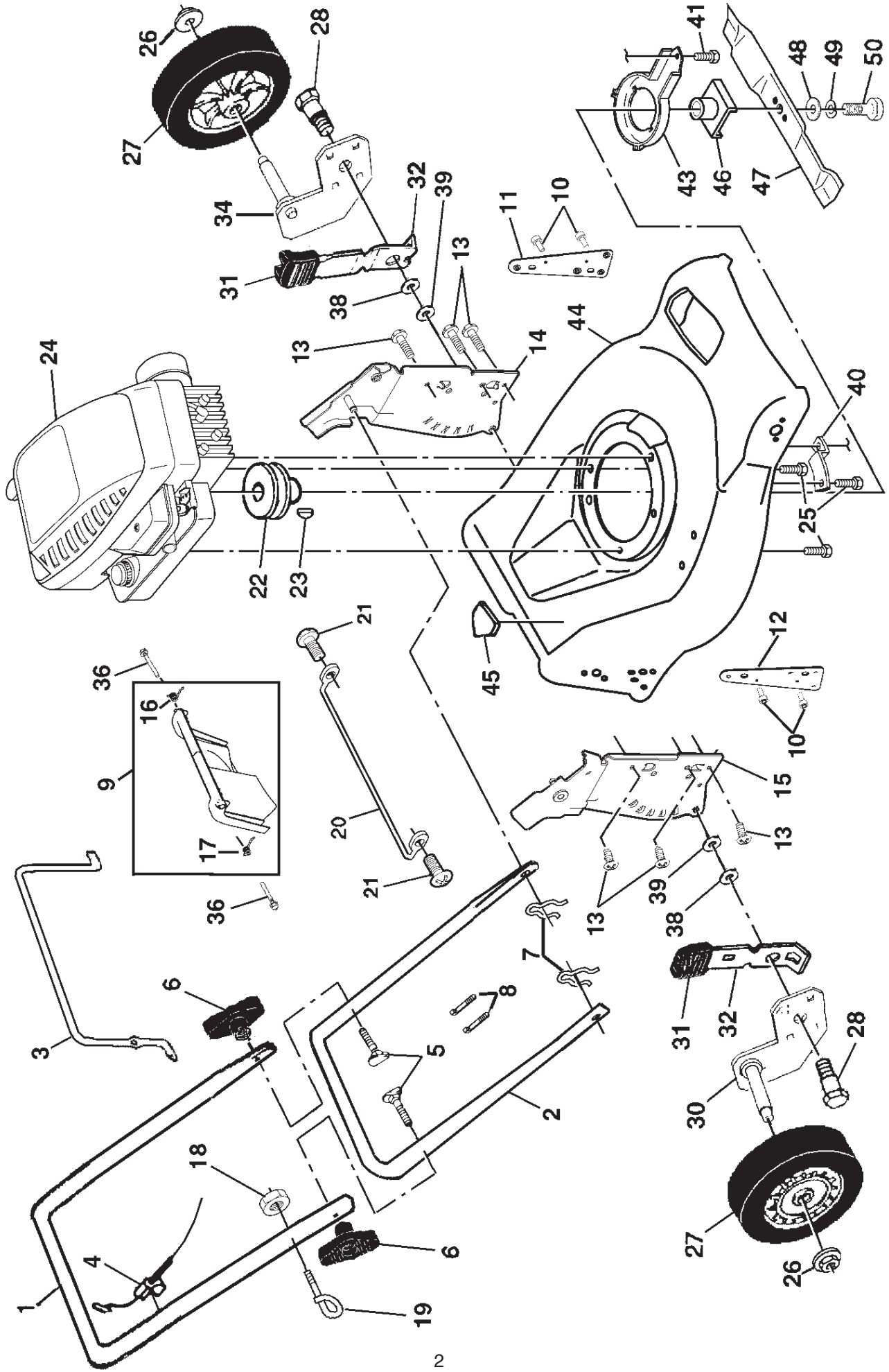

ROTARY LAWN MOWER - - MODEL NUMBER SN45Y21C (SN45Y21CA) PRODUCT NUMBER 964 77 11-03

KEY NO.	PART NO.	DESCRIPTION	KEY NO.	PART NO.	DESCRIPTION
1	532 19 25-17	Upper Handle	26	532 08 39-23	Hex Flange Nut
2	532 15 36-05	Lower Handle	27	532 18 04-06	Wheel
3	532 14 67-71	Control Bar	28	532 18 93-12	Shoulder Bolt 5/16-18 x .33
4	532 18 27-55	Engine Zone Control Cable	30	532 19 01-55	Axle Arm Assembly, RR
5	532 13 19-59	Handle Bolt	31	532 17 01-43	Selector Knob
6	532 19 19-38	Handle Knob	32	532 19 01-57	Selector Spring
7	532 05 17-93	Hairpin Cotter	34	532 19 01-56	Axle Arm Assembly, LR
8	532 06 64-26	Wire Tie	36	532 18 41-93	Bolt, Hex Head
9	532 18 04-79	Rear Door Kit (Includes Key Numbers 16 and 17)	37	532 17 61-85	Washer
10	532 12 84-15	Pop Rivet	38	532 17 62-35	Pushnut
11	532 18 25-38	Support Bracket, LH	39	532 17 61-85	Washer
12	532 18 25-39	Support Bracket, RH	40	532 19 09-39	Mounting Bracket, Debris Shield
13	817 06 04-10	Screw 1/4-20 x 5/8	41	532 18 80-40	Screw
14	532 19 01-54	Handle Bracket Assembly, LH	43	532 18 87-84	Debris Shield
15	532 19 01-53	Handle Bracket Assembly, RH	44	532 18 97-80	Kit, Lawn Mower Housing (Includes Key Numbers 10, 11, 12 and 45)
16	532 18 00-71	Spring, Rear Door, LH	45	532 18 21-66	Danger Decal
17	532 18 00-72	Spring, Rear Door, RH	46	532 18 00-69	Blade Adapter
18	532 13 20-04	Keps Locknut 1/4-20	47	532 17 50-52	Blade, 21"
19	532 17 95-85	Rope Guide	48	532 85 10-74	Hardened Washer
20	532 17 92-05	Foot Guard, C.E.	49	532 85 02-63	Helical Washer 3/8-24 x 1-3/8 Grade 8
21	532 05 45-83	Screw, Tapping 1/4-20 x 1/2	50	532 85 10-84	Hex Head Machine Screw 3/8-24 x 1-3/8 Grade 8
22	532 08 45-96	Engine Pulley	--	532 19 18-59	Operator's Manual, European
23	532 08 76-77	Hi-Pro Key			
24	---	Engine, Briggs & Stratton, Model Number 10M902 (order parts from engine manufacturer)			
25	532 15 04-06	Hex Head Thread Rolling Screw 3/8-16 x 1-1/8			

NOTE: All component dimensions given in U.S. inches.
1 inch = 25.4 mm

ROTARY LAWN MOWER -- MODEL NUMBER SN45Y21C (SN45Y21CA) PRODUCT NUMBER 964 77 11-03

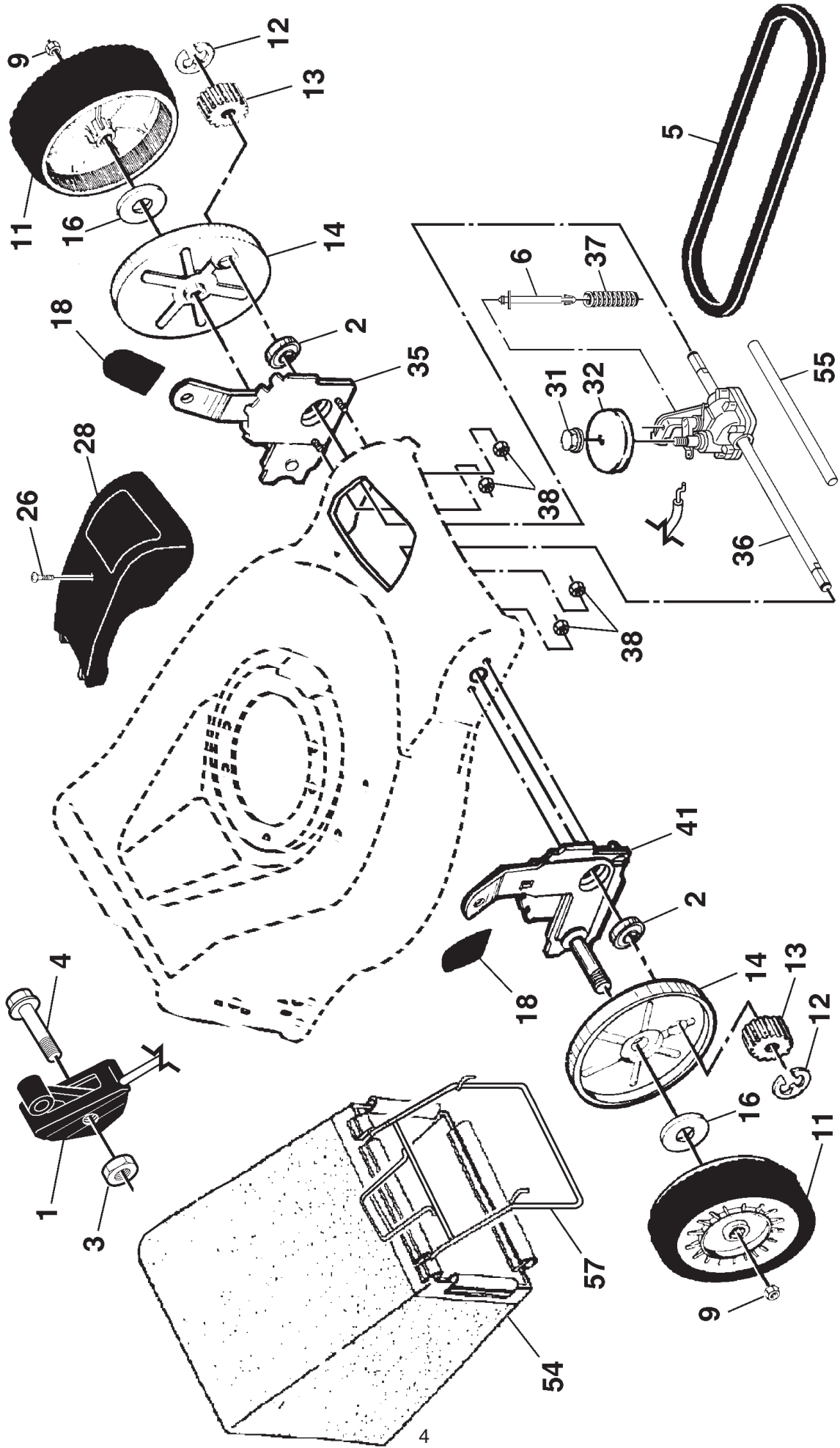

ROTARY LAWN MOWER - - MODEL NUMBER SN45Y21C (SN45Y21CA) PRODUCT NUMBER 964 77 11-03

KEY NO.	PART NO.	DESCRIPTION	KEY NO.	PART NO.	DESCRIPTION
1	532 18 45-87	Control Cable Assembly	31	532 13 20-10	Hex Flange Nut
2	532 16 73-87	Bearing, Wheel Adjuster	32	532 18 94-07	Drive Pulley
3	873 90 04-00	Locknut, Hex #10-24	35	532 15 20-18	Kit, Wheel Adjuster, LH (Includes Knob and Bearing)
4	532 15 87-55	Hex Washer Head Screw 1/4-20 x 2.12	36	532 18 01-84	Gearcase Assembly (See Breakdown)
5	532 17 54-36	V-Belt	37	532 13 70-90	Spring
6	532 15 04-95	Spring Retainer	38	873 80 04-00	Locknut 1/4-20
9	532 14 52-12	Locknut	41	532 15 20-19	Kit, Wheel Adjuster, RH (Includes Knob and Bearing)
11	532 18 07-66	Wheel & Tire Assembly	54	532 19 04-61	Grassbag Assembly
12	812 00 00-58	E-Ring	55	532 17 57-39	Driveshaft Cover
13	532 13 70-54	Pinion	57	532 18 88-15	Frame, Grassbag
14	532 18 94-03	Dust Cover			
16	532 06 77-25	Washer 1/2 x 1-1/2 x .134			
18	532 17 01-43	Selector Knob			
26	532 17 52-62	Pan Head Tapping Screw #10-24 x 2-3/4			
28	532 18 14-66	Drive Cover			

NOTE: All component dimensions given in U.S. inches.
1 inch = 25.4 mm

ROTARY LAWN MOWER - - MODEL NUMBER SN45Y21C (SN45Y21CA)

PRODUCT NUMBER 964 77 11-03

GEARCASE ASSEMBLY - PART NUMBER 532 18 01-84

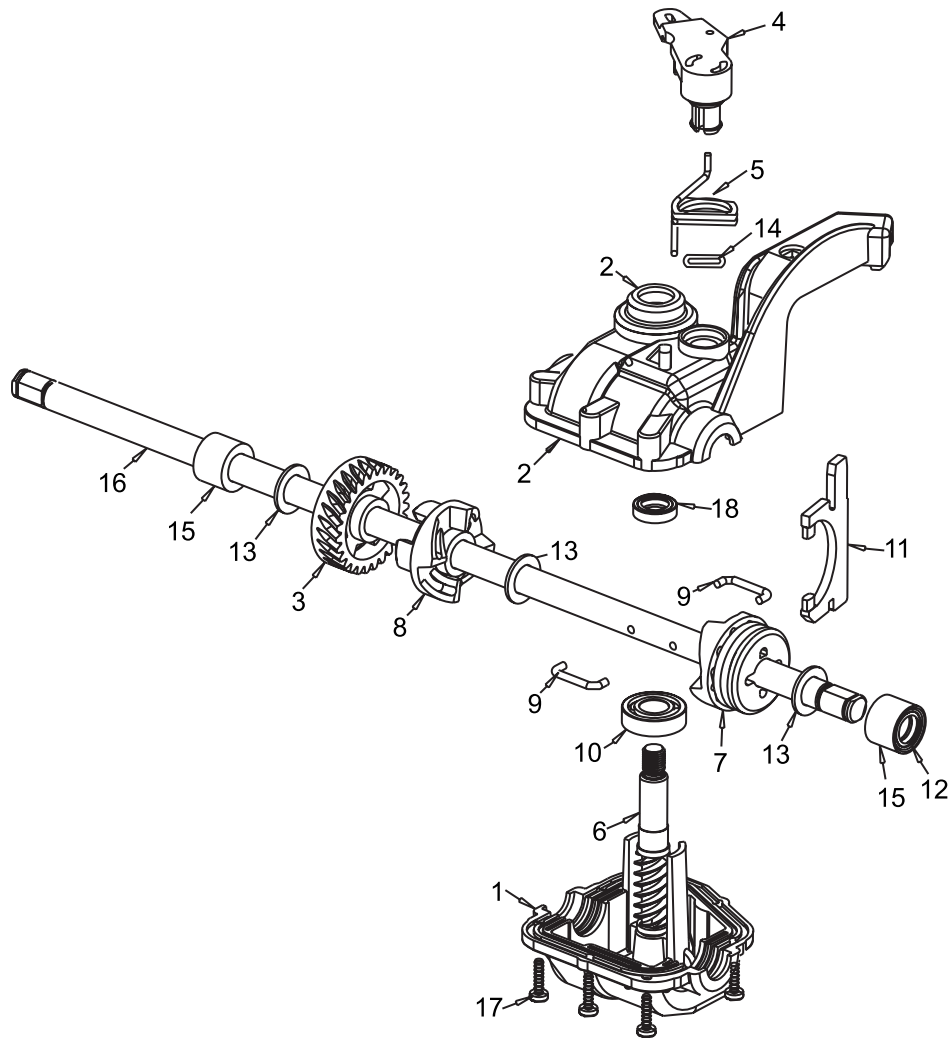

KEY NO.	PART NO.	DESCRIPTION
1	532 18 34-97	Case, Lower
2	532 18 34-98	Case, Upper
3	532 18 34-99	Gear, 27 Teeth
4	532 18 35-00	Lever, Clutch
5	532 18 35-01	Spring, Return
6	532 18 35-02	Shaft, Input
7	532 18 35-03	Dog, Movable
8	532 18 35-04	Dog, Fixed
9	532 18 35-05	Wire, Formed
10	532 18 35-06	Bearing, Ball
11	532 18 35-07	Fork, Shift
12	532 18 35-08	Seal, Output Shaft
13	532 18 35-09	Washer
14	532 18 35-10	Seal, Case
15	532 18 35-11	Bushing
16	532 18 35-12	Shaft, Output
17	532 18 35-13	Screw
18	532 18 35-14	Seal, Input Shaft
--	532 18 34-04	Kit, Gearcase Replacement

NOTE: Use Dow Corning #709 to reseal Gear Case Halves.

NOTE: All component dimensions given in U.S. inches.
1 inch = 25.4 mm